



Direct-Fired Jet Heater

KG300

User manual and Installation Instruction



GAS

GASOIL

Dear user, it is mandatory to observe and implement the provisions of this manual.

Please read and follow it carefully.

Otherwise, KOOLAK GOSTAR YAZD Company will not be responsible for potential accidents.

We appreciate your purchase

We are confident that you will be satisfied with your acquisition from **KGY**.



Direct-Fired Jet Heater

KG300

With the confirmation certificate of the European Union and four international standards, we affirm that the design and modeling of this equipment have been completed in our company. It possesses the quality and safety features authorized by the European Union.

	<p>To ensure the proper, effective and permanent performance of the heater, as well as your safety, we sincerely ask you to read this installation pamphlet carefully and completely. Pay attention to warnings and safety instructions before installation and for the repair and maintenance of the heater.</p> <p>The consequences of not reading the latest version of the manual are the responsibility of the customer.</p> <p>You can always download the latest version of the user manual at www.kgy-ind.com</p>
---	---



Table of Contents

1 GENERAL INFORMATION4

1-1 TARGET GROUPS.....4

These instructions are intended for:4

Target group requirements:4

1-2 SIGNS5

1-3 SPECIAL SAFETY INSTRUCTIONS5

1-4 GENERAL SAFETY INSTRUCTIONS5

1-5 ELECTRICAL EQUIPMENT6

1-6 MAINTENANCE.....6

1-7 SPARE PARTS ORDERING7

1-8 RESPONSIBILITY7

1-9 WARRANTY7

1-10 POWER OUTAGE7

1-11 FIRST AID8

1-12 WASTAGE8

1-13 CALL INFORMATION8

2 TECHNICAL FEATURES9

2-1 INTRODUCTION9

2-2 TECHNICAL SPECIFICATIONS.....9

2-3 HEATER DIMENSIONS.....10

2-4 SYSTEM.....11

3 INSTALLATION12

3-1 INSTALLATION OBLIGATIONS12

3-2 INSTALLATION GUIDE.....13

3-3 ELECTRICITY.....15

3-4 CONTROL PANEL OVERVIEW15

3-5 ELECTRICAL DIAGRAM16

THE ELECTRICAL DIAGRAM FOR THE DEVICE IS PROVIDED BELOW:16

3-6 INPUT FUEL.....17

3-7 INITIATION17

3-8 TURNING OFF.....17

3-9 ADJUSTMENT18

4 TROUBLESHOOTING18

4-1 SERVICE.....19

5 ACCESSORIES21

5-1 PART LIST:21

5-2 SPARE PARTS22

 5-2-1 *Ambient Thermostat*.....22

 5-2-2 *Air Transfer Duct*.....22

1 General Information

This instruction has been compiled to guide you, dear consumer, not only in learning how to turn on the heater but also in understanding the general details of its electrical panel and gaining the ability to troubleshoot your system. Always keep a copy of this manual next to the heater so that the operator can comprehend the safety tips, especially if they are not familiar with the heater. Share the following tips with anyone working with the heater to prevent problems and potential injuries:

- **How to turn on and adjust the heater**
- **How to turn on/off the heater and operate the thermostat**
- **How to control the heating system, flue, and channel installation**

Ensure the heater is serviced by a technician once a year to guarantee its correct performance. Consult an expert to address any issues with the electric motor or burner.

1-1 Target Groups

These instructions are intended for:



- Installers tasked with the assembly (if applicable) and/or mechanical installation of this heater.
- Electricians tasked with the electrical installation of this heater.
- Operators tasked with the operation of this heater.
- Maintenance technicians tasked with maintenance and troubleshooting of this heater.

Target group requirements:



- Installers must have sufficient relevant experience or training in the installation of this type of Heaters.
- Electricians must be qualified electricians.
- Operators must have sufficient relevant experience or training in operating this type of heaters.
- Maintenance technicians must have sufficient relevant experience or training in maintaining and troubleshooting this type of heaters.

1-2 Signs

While reading this manual you'll face these signs:

	<p>General Hazard Warning</p>
	<p>Electrical Hazard Warning</p>
	<p>Protective Glove Use</p>

1-3 Special Safety Instructions

	<p>Caution</p>	<p>This sign indicates a possible hazard or unsafe practice that could injure you or damage the heater.</p>
	<p>Attention</p>	<p>Next to this sign, you will find information on how to use the heater properly and efficiently and how to create an ideal ambient condition.</p>

1-4 General Safety Instructions

This heater is designed for use in industrial halls, poultry farms, and construction sites. Its use in other locations is only acceptable if approved by the company's consultants and technical experts. The producer is not liable for the consequences resulting from improper use, and the user bears full responsibility for potential incidents and damages.

- The presence of a factory-authorized serviceman is mandatory for the initiation, maintenance, and installation of the heater.
- Compliance with obligatory regulations for incident prevention, along with adherence to all other formal regulations such as occupational medicine and safety, is required.

Caution: This manual does not address the general hazards of fire. Call your local fire department for guidance and information.

1-5 Electrical Equipment

	<p>In livestock and poultry farms, the accumulation of compost can lead to the formation of hazardous and poisonous gases, such as hydrogen sulfide (sewer gas) and methane. The presence of these gases can pose a serious risk, especially during activities like moving and washing the compost, potentially causing a significant explosion in the presence of fire.</p> <p>To prevent dangerous incidents, it is crucial to turn off the heaters before moving and washing the compost. Additionally, adhere to the following safety measures:</p> <ul style="list-style-type: none"> - Close the doors during compost accumulation outdoors. - Ensure constant air conditioning and ventilation
---	---

- All the matters related to the maintenance and repair of the heater must be handled by experts.
- Before initiating maintenance and repair procedures ensure the heater is unplugged.
- Prior to starting the heater, inspect all electrical wiring and make sure they are undamaged.
- Before activating the heater, have electricians identify and replace any damaged wires and components within the system.
- Covering the electro-motors may elevate the temperature and potentially leading to damage the heater and, in extreme cases, causing a fire.

1-6 Maintenance

	<p>Before performing maintenance and repairs ensure that the heater is unplugged.</p>
---	--

Caution: For maintenance procedures on the heater, refer to the manual. Any repairs must be carried out exclusively by the authorized servicemen of the company, and they should be entrusted with the task.

Caution: Maintenance, repairs, and cleanliness of the heater should be conducted when the heater is turned off, and the electro-motor has been stopped. This aspect should be taken into consideration even when addressing partial deficiencies during repairs

	<p>If there is a possibility of hand injury, use the protective gloves.</p>
---	--

After the repair process, the customer should be satisfied with the results. Do not restart equipment before implementing all safety considerations.

The exact technical features of spare parts must be provided, ensuring they possess the necessary quality features. This requirement ensures the originality of the parts.

1-7 Spare Parts Ordering

when ordering the spare parts, consider the following points:

- Intended piece code with its description
- Bill's code of initial purchase
- Electrical features, such as 380Volt,3phase, 50 hertz

1-8 Responsibility

Any change applied to the heater without the supervision of company representatives absolve our responsibility for potential damages.

The consequences of unstandardized adjustment of the flame formation system rest on the customer; hence, it is recommended that all matters related to installation, initiation, service, repair and adjustment of the injection system and flame formation should be handled by factory-authorized servicemen or individual trained and confirmed by KOOLAK GOSTAR YAZD.

1-9 Warranty

Always keep the warranty card with you to avail yourself of the warranty and after-sales service for KOOLAK GOSTAR YAZD products. The product specification plate, located on the heater, must not be removed under any circumstances. This plate contains crucial electrical, mechanical, and identification information.

Each Heater is assigned a unique serial number, which is indicated on its respective plate. Retain the serial number for future reference.

1-10 Power outage

It is recommended to install warning systems on your equipment to protect your assets, animals and plants.

In the event of power outage, an emergency power system with a voltage stabilizer regulator must be immediately activated. Contact your insurance company for more information.

1-11 First Aid

First Aid box should always be available in the workplace for immediate aid provision in case of incidents. Replace any material and instrument used as soon as possible. When seeking help, provide the following information:

- Where did the incident happen?
- What happened?
- How many people are injured?
- What kind of injuries happened?
- Who is reporting the incident?

1-12 Wastage

After installation or repair, dispose of packing and other waste materials in appropriate places (like retrieval)

1-13 Call Information

Factory Address: Iman Street – Hossein Abad Rismani – Yazd – Iran

Telephone number: 035-38369990-9 / 035-38369560-1

Website: www.kgy-ind.com

Fax: 035-38369505

Email: info@kgy.ir



**The contents of this manual may change without prior notice.
If you encounter any errors or incorrect information, we would appreciate being informed.
All photos, logos, and content in this booklet belong to KGY Company and copying them without mentioning the company's name is illegal.**

2 Technical Features

2-1 Introduction

KOOLAK GOSTAR YAZD has unveiled its powerful 300,000 kcal/h direct-fired jet heater, introducing significant advancements in control systems, flame formation, and safety mechanisms compared to conventional models. The heater is now available for both domestic and international markets.

This innovative jet heater boasts exceptional heating and airflow capabilities, coupled with an attractive price point. Its versatility allows for ground or overhead installation, and it operates efficiently on both gas and gasoil fuel. Moreover, the heater's remarkably low emissions and near-100% efficiency make it an ideal choice for industrial halls, poultry farms, and construction sites.

2-2 Technical Specifications



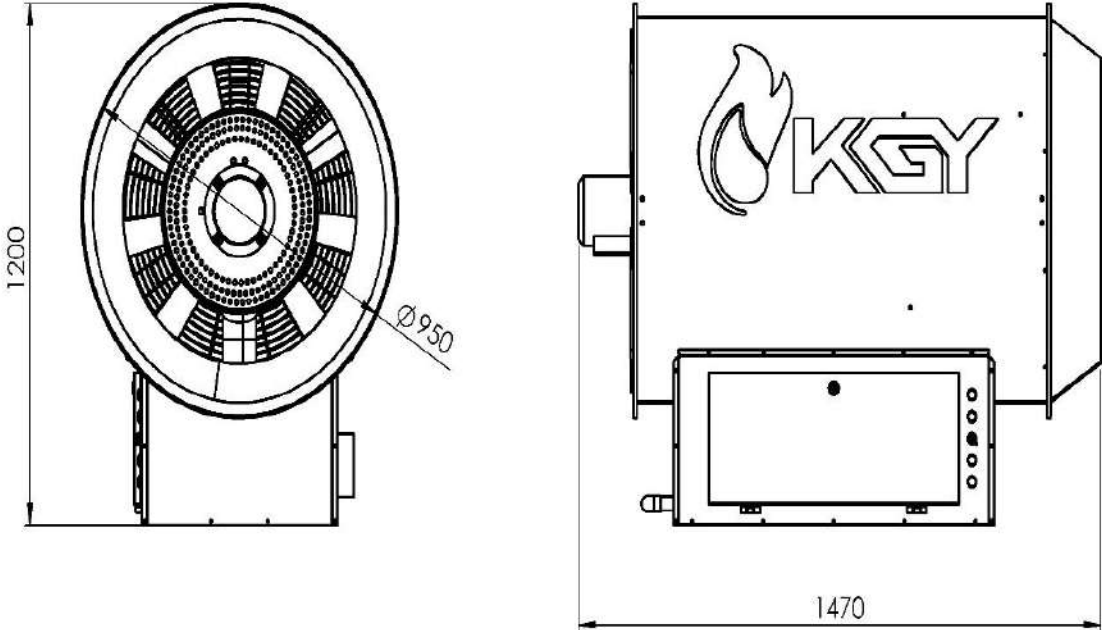

Technical Specification	Jet300
Power Supply (Ph-V-Hz)	3-380-50
Weight (Kg)	110
Capacity (Kcal/h)	300,000
Airflow (CFM)	14700
Dimension (cm) (length× width×height)	120×95×147
Outlet Diameter (cm)	80
Electric Motor (kW-RPM)	1.5 - 900
Burner Electric Motor (W-RPM)	240-2700
Fan Diameter (cm)	88
Covered Space (m ³)	3000-8000
Gas Pressure (mbar)	18-25
Fuel Consumption (m ³ /h)	18-29
Electric Current (A)	4.5



2-3 Heater Dimensions



2-4 System

The use of a control system assembled with safety equipment, ensures the secure operation of the heater. Safety features are integrated into the heater to prevent dangerous accidents and damage. The comprehensive list of safety, control, electrical and mechanical equipment used in this heater is provided in the table below.

<p>Gasoil pump: A gasoil pump transfers gasoil fuel to the fuel injector, providing the necessary pressure behind the nozzles. The pump is powered by the electric motor of the burner through direct coupling.</p>	
<p>Gas valve: It connects and disconnects the gas input to the heater</p>	
<p>Mode selection switch: Using the zero and one switches to start the fan independently when you need to ventilate the place without heating and the switch to put the heater in automatic mode to start the burner and fan automatically</p>	
<p>Gasoil filter: A gasoil filter is employed to prevent impurities from entering the burner pump and blocking the nozzle.</p>	
<p>Handles: Specially designed foldable handles ensure easy and safe transportation of the heater.</p>	

<p>12 A Contactor: Contactors are employed to control various loads, including electric motors, circuits, and other electrical equipment.</p>	
<p>Burner Relay: The Burning Control Unit (BCU) oversees the combustion process, and in case of an issue, extinguishes the flame while providing an error message.</p>	
<p>Microswitch: It controls the operation of the fan, so that if it is off, it prevents the burner from turning on and causing a fire.</p>	

3 Installation

3-1 Installation Obligations

Note: This heater is designed for use in spaces with continuous ventilation. If used in unventilated spaces, there is a risk of suffocation. Therefore, proper and continuous ventilation is essential in the area of use.

Note: The number of heaters required depends on the size and shape of the desired space, the desired temperature, and the weather conditions of your area. For advice and guidance, you can contact the company's experts.

3-2 Installation Guide

Prior to installation pay attention to following points:

- Install the heater in its place on a stable base to prevent vibration during operation. Alternatively, you can hang the heater from the ceiling with the help of three strong chains or cables.
- The base's height should be at least one meter from the ground.
- If the heater is installed next to the wall, ensure it is at least one meter away from the wall on each side.
- Ensure there are no obstacles in the air inlet and outlet of the main fan and burner fan.
- Avoid placing the heater in locations with a risk of fire
- The inlet air required for combustion must be supplied from outside the hall through a duct channel with a diameter equal to the diameter of the burner air inlet. Failure to install this channel will affect combustion air due to the suction of the main fan of the heater

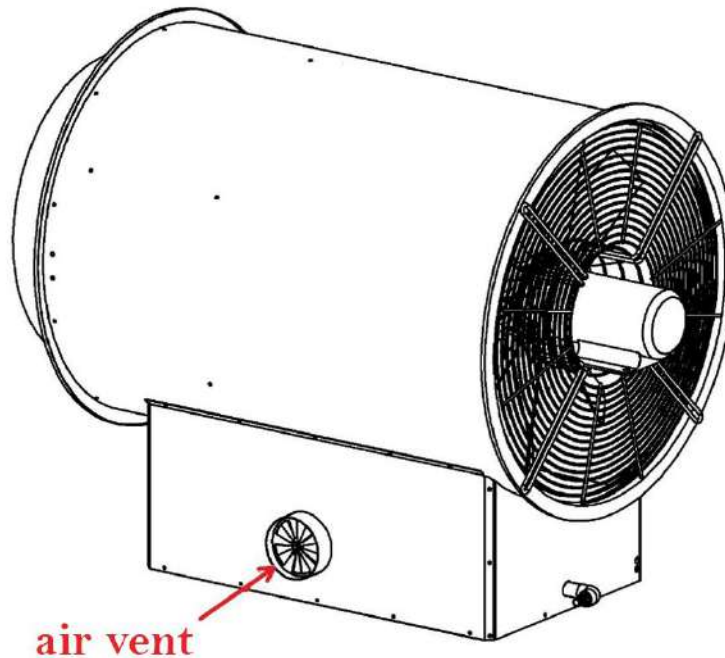

- Ensure that in gasoil heaters, the gasoil tank level is higher than the gasoil pump level of the heater (in suspended and floored models). Otherwise, fueling will not be done completely, and the gasoil pump and burner electromotor will be damaged.
- Note that in all cases, the entrance fuel connection, whether gas or gasoil, should be standard and performed by experts using completely standard equipment
- When there is no possibility of a permanent connection for gasoil to the heater, you should disconnect the pump and motor shaft connection

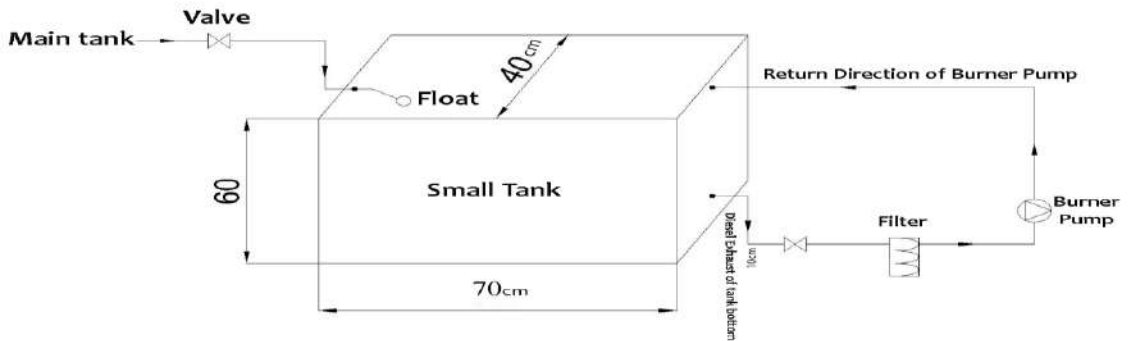

Gasoil Connection Route

	<p>Any task related to the heater, including installation, repair and adjustment of the gas input conversion as well as connection to the natural electricity and gas system, should be carried out by the company's experienced servicemen using high-quality and standard connections.</p> <p>During installation, strict adherence to the rules of the electricity and gas companies in your area is essential.</p>
--	--

	<p>Before installation, ensure to coordinate with the regional gas company to verify that the distribution conditions of natural gas and the type and pressure of gas align with the settings of the heater.</p>
---	---

3-3 Electricity

Access to the electric control unit is possible by opening the panel with a specialized switch. The heater's electric connection program is shown in the picture, Additionally, a service light facilitates easy maintenance and repairs within this enclosure.



3-4 Control Panel Overview



Black Switch: Automatic Operation

- **Right Turn:** Initiates automatic operation, activating the burner and main fan.
- **Left Turn:** Turns the device off under normal conditions.
- **Extreme Left Turn:** Activates the main fan without igniting the burner, enabling ventilation and air circulation.

Blue Light: Burner Indicator

- **Illuminated:** Indicates an active burner.

Green, Yellow, and Red Lights: Phase Indicators

- **Illuminated:** Signifies the presence of all three phases in the electrical system.

	<p>In the event of a power outage during operation, there is a possibility of damaging the furnace. To mitigate potential danger, it is essential to have an emergency power source.</p>
--	---

3-5 Electrical Diagram

The electrical diagram for the device is provided below:

Burner Command Circuit

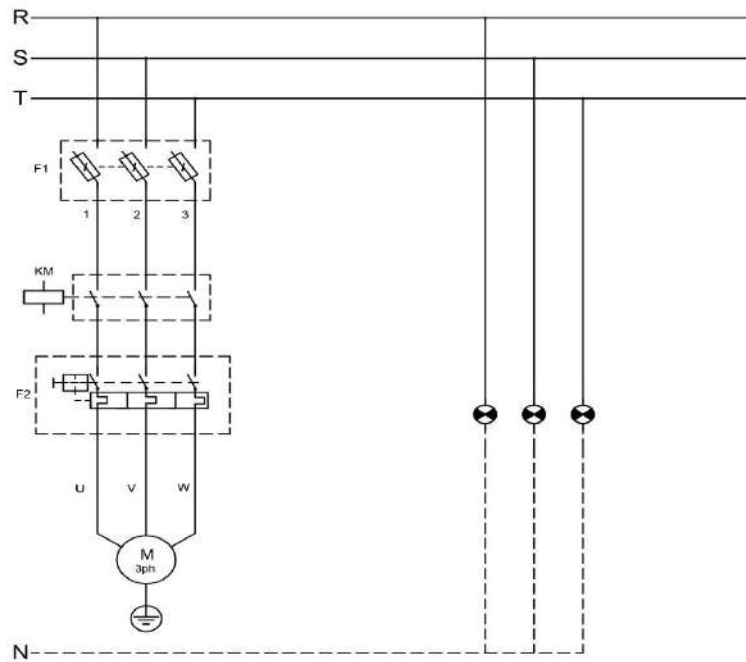

Fan Power Circuit

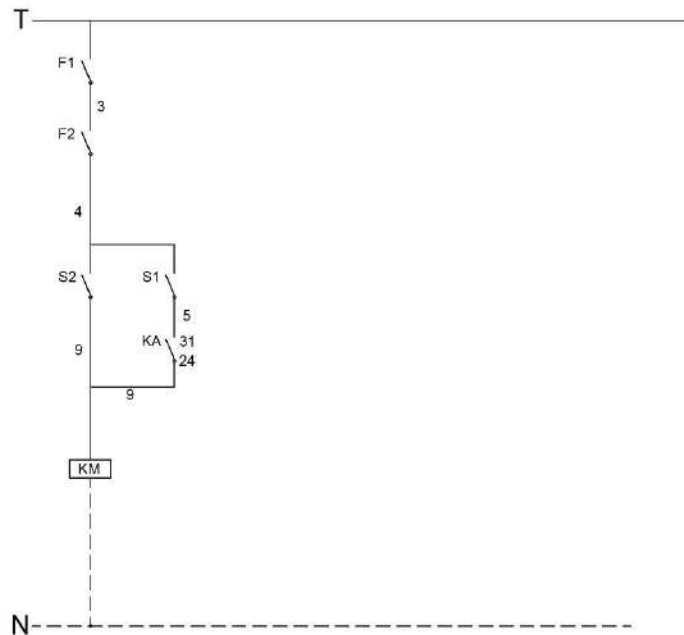

Fan Command Circuit

3-6 Input Fuel

KGY jet heater includes gas and gasoil models.

3-7 Initiation

After completing the previous steps appropriately

- 1) Connect the input electricity.
- 2) Connect the ambient thermostat to turn the heater on and off.
- 3) Choose the type of fuel by the dual-mode switch on the electrical panel door (only for dual-fuel heaters)

3-8 Turning Off

If you use an ambient thermostat, the heater will turn on and off automatically based on the ambient temperature. To keep it off, set the three-mode switch on the door of the electrical panel (manual fan switch off-automatic) to the off mode.

If you do not use an ambient thermostat, to turn it off, put the three-position switch on the door of the electrical panel (manual fan switch off automatic) to the off position.



Always be cautious that the emergency stop switch is for critical conditions and should not be used to turn the heater off in normal circumstances.

	While the heater is on, avoid standing directly in front of the heater and its flame.
---	--

	Ensure that there are no obstructions within three meters of the heater's outlet.
---	--

3-9 Adjustment

Gas, gasoil, and air mixture rate adjustments should be performed by the factory's technical expert. Incorrect adjustments can lead to reduced ignition quality, suboptimal fuel usage, and potential danger.

	If adjustments, repairs, or part replacements are needed, contact the factory or authorized servicemen.
---	--

4 Troubleshooting

	All the necessary actions should be carried out by authorized company servicemen
---	---

If, for any reason, the heater's performance is disturbed, check the following points

- 1) If you intend to change the type of fuel in dual-fuel heaters, it is possible that the heater may not turn on initially. In this case, repeat the startup process several times (put the switch in automatic mode and wait for the burner to turn on).
- 2) Check the fueling system path, ion wires, igniter, and the placement spot of the photocell (light receiver). Ensure that light doesn't reach the photocell.
- 3) Ensure the earth wire is properly connected to the heater. (The gas heater won't turn on without an earth wire connection)
- 4) Gasoil pressure is factory-adjusted for gasoil heaters and doesn't need changes. For gas heaters, gas pressure should be adjusted by an expert at the installation site or you can contact the technical support team of the company.
- 5) Ensure proper ventilation for gas or gasoil tubes connected to the heater
Fumes in the exhaust indicate incomplete ignition caused by the unadjusted entrance air of the burner. Adjust the entrance air with the help of an expert.
To do this:
 1. Open the heater's side valve (located on the cylinder part).
 2. Loosen the stabilizer nut in the air entrance. By adjusting the air with the air adjustment nut, change the amount of entrance air, then tighten the stabilizer nut again.
 3. To access the gasoil pump for pressure adjustment, open the rectangular valve door next to the electrical panel. Turn the pressure adjustment key to adjust the pump



4-1 Service

	Do not use water to clean the heater, as improper cleaning can damage it
---	---

At least once a year, the heater should be adjusted and checked by an expert. Also, at appropriate intervals, dust in the heater must be completely removed. Do not use water for this process; instead, clean the heater using an air compressor.

	Before initiating any service or maintenance procedures, turn off the main power. All service and maintenance tasks must be performed by trained and factory-approved personnel.
---	---

- Check the burner and electromotor performance every two month
- Check the burner nozzle every six months and change if clogged
- Examine the thermocouple every six months and replace it if damaged.
- Periodically clean the gasoil filter, ensuring its health, and replace it after a year.
- Regularly check the electric connections of wires, terminals, and thermocouples. Ensure they are tight.
- Tighten the electrical panel annually and ensure that connections and screws are secure.
- Do not allow water and dust to enter the electrical panel. If it happens, cut off the input power, dry, and clean the panel thoroughly.

	<p>In all the above cases, it is mandatory to diagnose and fix the fault by authorized servicemen.</p>
---	---

	<p>Refrain from using water for cleaning purposes. Instead, employ an air compressor to remove dust and debris.</p> <p>Improper cleaning techniques may damage the equipment.</p> <p>Before proceeding with any maintenance tasks, ensure the main power supply is disconnected.</p> <p>Authorized and trained personnel should handle all service and maintenance procedures.</p>
---	--

5 Accessories

5-1 Part List:

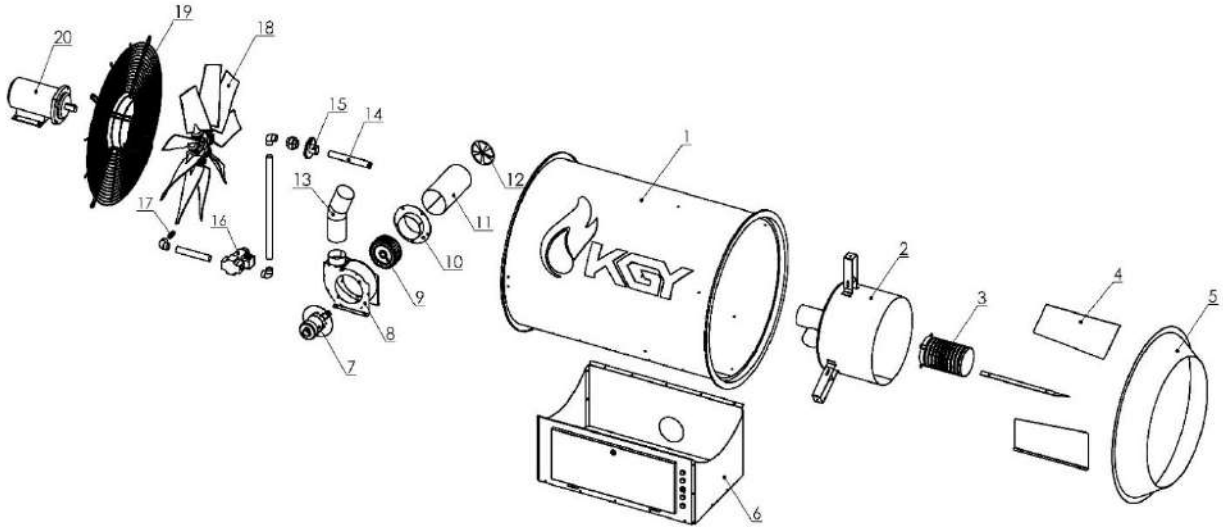

1	Body	11	Air vent duct adapter
2	Combustion chamber	12	Burner air adjustment valve
3	Gas collector	13	Burner's snail-like
4	windbreak	14	Air inlet
5	Conical	15	Heat exchanger
6	Equipment box	16	Air vent connector pipe
7	Burner's motor	17	Hose connection
8	Burner's fan body	18	Axial fan
9	Burner's fan	19	Protective grille and motor connection
10	Flange	20	motor

5-2 Spare Parts

5-2-1 Ambient Thermostat

To regulate the temperature of an environment, an ambient thermostat can be used. It maintains environment's temperature at a desired value by controlling the cooling and heating equipment. Beyond automatic device operation, this function significantly contributes to reducing energy consumption. Ambient thermostats can be analog, or digital and utilize an automation system.



5-2-2 Air Transfer Duct

A duct pipe, characterized by a trunk-like body, offers high flexibility. This type of duct is employed to supply incoming air to the burner. It is crucial to use this equipment since the high suction of the fan can disturb the air around the device, affecting proper flame formation. Confirm that the diameter of the air duct matches the diameter of the air inlet of the burner when selecting the duct.





Direct-Fired Jet Heater

KG300

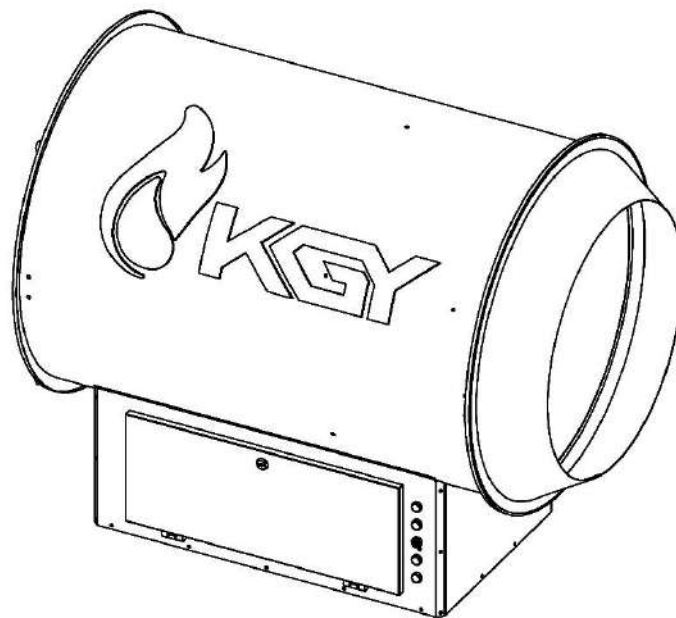

Add: ST. IMAN, HOSSEINABAD RISMANI, YAZD, IRAN

Tel: +98 35 38369990-9 Fax: +98 35 38363505

Website: WWW.KGY-IND.COM Email: Info@KGY.ir